

PLEASE CHECK WWW.MOLEX.COM FOR LATEST PART INFORMATION

Part Number: [0003062061](#)
Status: **Active**
Overview: [standard_062](#)
Description: 1.57mm (.062") Diameter Standard .062 Pin and Socket Plug Housing, 6 Circuits, Without Mounting Ears

Documents:

3D Model	Product Specification PS-02-06 (PDF)
Drawing (PDF)	RoHS Certificate of Compliance (PDF)
Packaging Specification (PDF)	

Agency Certification

CSA	LR19980
TUV	R72081037
UL	E29179

General

Product Family	Crimp Housings
Series	1625
Comments	Polarized to Mating Part
Overview	standard_062
Product Name	Standard .062"

Physical

Breakaway	No
Circuits (maximum)	6
Circuits Detail	2x3
Color - Resin	Natural
Flammability	94V-2
Gender	Plug
Glow-Wire Compliant	No
Keying to Mating Part	None
Lock to Mating Part	Yes
Material - Resin	Nylon
Number of Rows	3
Packaging Type	Bag
Panel Mount	No
Pitch - Mating Interface (in)	0.145 In
Pitch - Mating Interface (mm)	3.68 mm
Pitch - Term. Interface (in)	0.145 In
Pitch - Term. Interface (mm)	3.96 mm
Polarized to Mating Part	Yes
Stackable	No
Temperature Range - Operating	-40°C to +105°C

Electrical

Current - Maximum per Contact	5A
-------------------------------	----

Material Info

Old Part Number	1625-6P1
-----------------	----------

Reference - Drawing Numbers

Packaging Specification	PK-1625-001
Product Specification	PS-02-06
Sales Drawing	SD-1625-6*

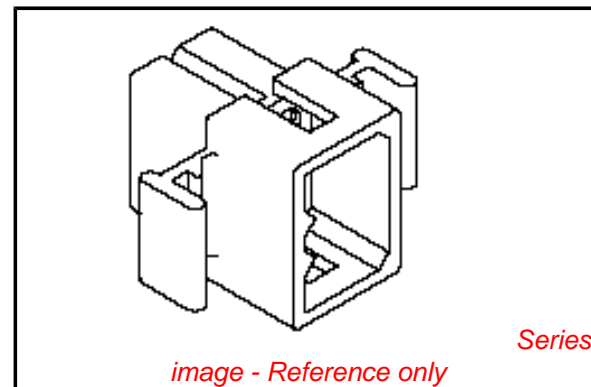

EU RoHS

ELV and RoHS Compliant
REACH SVHC
Contains SVHC: No
Halogen-Free Status

China RoHS



Need more information on product environmental compliance?

Email productcompliance@molex.com
 For a multiple part number RoHS Certificate of Compliance, [click here](#)

Please visit the [Contact Us](#) section for any non-product compliance questions.

Search Parts in this Series

[1625Series](#)

Mates With

[1625](#) Receptacle

Use With

Female Crimp Terminals [1561](#)[Link:4559](#), [4529](#), [2190](#), [2189](#), [1787](#), [1855](#). Male Crimp Terminals [1560](#), [1786](#), [1854](#), [1778](#). Male PC Tail Terminals. [1779](#) Female PC Tail Terminals

This document was generated on 06/07/2010

PLEASE CHECK WWW.MOLEX.COM FOR LATEST PART INFORMATION

RECEPTACLE

PLUG

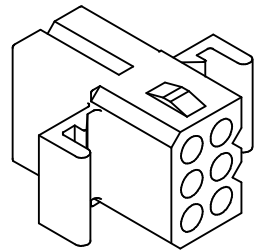
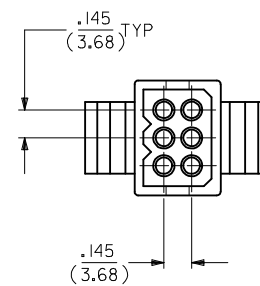
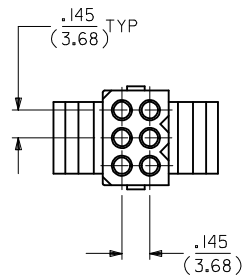
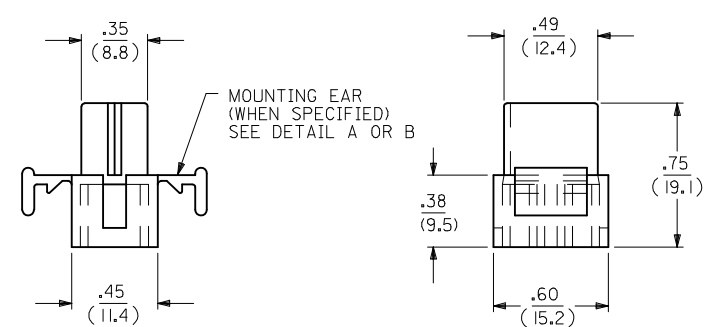
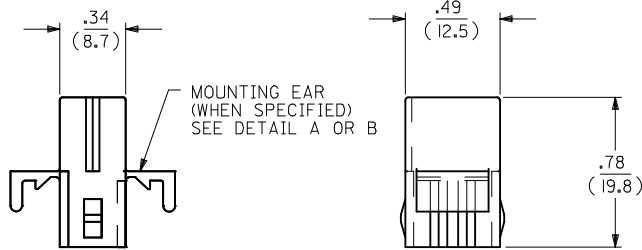
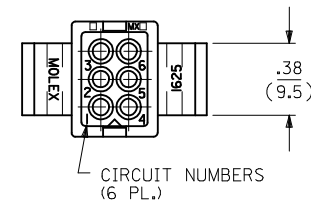
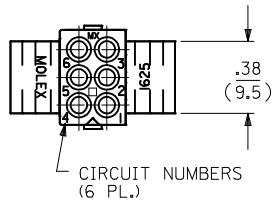

SHOWN WITH STANDARD EAR

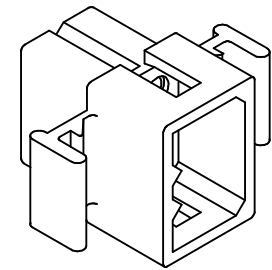

SHOWN WITH STANDARD EAR

UPDATE TITLE BLOCK EC NO: UCP2006-1431 DRW: NAEHAG 2006/08/29 CHKD: SCHMIDT 2006/08/29 APPR: FSMITH 2006/08/30	QUALITY SYMBOLS ▽=0 ▽=0	GENERAL TOLERANCES (UNLESS SPECIFIED) mm INCH 4 PLACES ± --- ± --- 3 PLACES ± --- ± .010 2 PLACES ± 0.25 ± .014 1 PLACE ± 0.35 ± --- ANGULAR ± 1/2°	DIMENSION STYLE IN/MM DRAWN BY DATE KBW 7/22/88 CHECKED BY DATE RW 7/22/88 APPROVED BY DATE RAS 7/22/88	SCALE --- DESIGN UNITS INCH THIRD ANGLE PROJECTION	
	TITLE .062/(1.57) HOUSING PLUG & RECEPTACLE 6 CKT, .145/(3.68) C.L.			MOLEX MOLEX INCORPORATED	
	MATERIAL NO. SEE CHART			DOCUMENT NO. SD-1625-6*	SHEET NO. 1 OF 2
	DRAFT WHERE APPLICABLE MUST REMAIN WITHIN DIMENSIONS THIS DRAWING CONTAINS INFORMATION THAT IS PROPRIETARY TO MOLEX INCORPORATED AND SHOULD NOT BE USED WITHOUT WRITTEN PERMISSION				

PLUG		
ORDER NO	ENG NO	
03-06-2062	I625-6P	
03-06-2061	I625-6P1	
03-06-7062	I625-6PBK	
03-06-7061	I625-6P1BK	
03-06-7063	I625-6POR	OBSOLETE
-	-	

RECEPTACLE		
ORDER NO	ENG NO	
03-06-1061	I625-6R	
03-06-1062	I625-6R1	
03-06-6061	I625-6RBK	
03-06-6062	I625-6R1BK	
03-06-6063	I625-6ROR	OBSOLETE
03-06-6064	I625-6RBU	
NOT TOOLED	I625-6R2	

LEGEND:

I625-6****

CIRCUIT SIZE

P = PLUG
R = RECEPTACLE

BLANK = WITH STANDARD EARS
1 = WITHOUT EARS
2 = WITH PREBENT EARS

COLOR:

BLANK = NATURAL COLOR
AM = AMBER BK = BLACK BU = BLUE
BN = BROWN GY = GRAY GN = GREEN
OR = ORANGE RD = RED YW = YELLOW

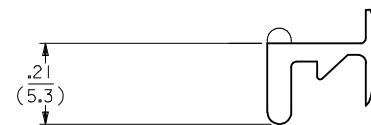

DETAIL A

.062/(1.57) STANDARD MOUNTING EAR
(SCALE 4:1)

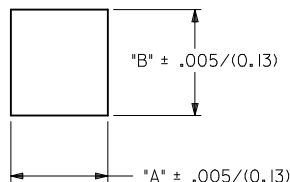
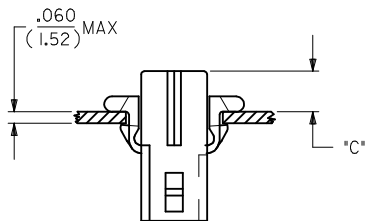

HOUSING	DIM. "A"	DIM. "B"	"C" PREBENT EAR	"C" STANDARD EAR
PLUG	.607/(15.42)	.615/(15.62)	.22/(5.6)	.18/(4.6)
RECEPT.	.505/(12.83)	.552/(14.02)	.23/(5.8)	.19/(4.8)

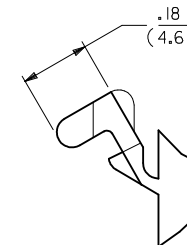
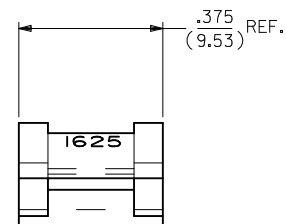

DETAIL B

.062/(1.57)PREBENT MOUNTING EAR
(SCALE 4:1)

NOTES:-

1. MATERIAL NYLON TYPE 6/6, 94-2.
2. FINISH: NONE.
3. PRODUCT SPECS: MOLEX PRODUCT SPECS 02-06 APPLIES.
4. PACKAGING SPECS: BULK PACK PER PK-1625-001.

REINSTATE PARTS EC NO: UCP2006-1431 DRWINAELHAG 2006/08/29 CHKD:LSCHMIDT 2006/08/29 APPR:FSMITH 2006/08/30	QUALITY SYMBOLS ▽=0 ▽=0	GENERAL TOLERANCES (UNLESS SPECIFIED) <table border="1"> <tr> <th></th> <th>mm</th> <th>INCH</th> </tr> <tr> <td>4 PLACES</td> <td>± .010</td> <td>± .0004</td> </tr> <tr> <td>3 PLACES</td> <td>± .010</td> <td>± .0004</td> </tr> <tr> <td>2 PLACES</td> <td>± 0.25</td> <td>± .010</td> </tr> <tr> <td>1 PLACE</td> <td>± 0.35</td> <td>± .014</td> </tr> </table>		mm	INCH	4 PLACES	± .010	± .0004	3 PLACES	± .010	± .0004	2 PLACES	± 0.25	± .010	1 PLACE	± 0.35	± .014	DIMENSION STYLE IN/MM	SCALE ---	DESIGN UNITS INCH	THIRD ANGLE PROJECTION
		mm	INCH																		
	4 PLACES	± .010	± .0004																		
	3 PLACES	± .010	± .0004																		
2 PLACES	± 0.25	± .010																			
1 PLACE	± 0.35	± .014																			
DRAWN BY KBW	DATE 7/22/88	TITLE .062 / (1.57) HOUSINGS PLUG & RECEPTACLE 6 CKT, .145/(3.683) C.L.																			
CHECKED BY RW	DATE 7/22/88	MOLEX INCORPORATED																			
APPROVED BY RAS	DATE 7/22/88	MATERIAL NO. SEE CHART	DOCUMENT NO. SD-1625-6*	SHEET NO. 2 OF 2																	

DRAFT WHERE APPLICABLE
MUST REMAIN
WITHIN DIMENSIONS

THIS DRAWING CONTAINS INFORMATION THAT IS PROPRIETARY TO MOLEX INCORPORATED AND SHOULD NOT BE USED WITHOUT WRITTEN PERMISSION